

Harol Sun Protection



NEW

LED Lighting
with dimmable atmospheric on
the LX530 and the BX270

Read more at page 12 and 20

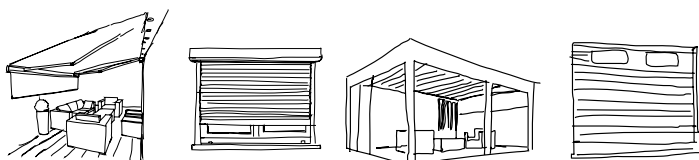

HAROL®

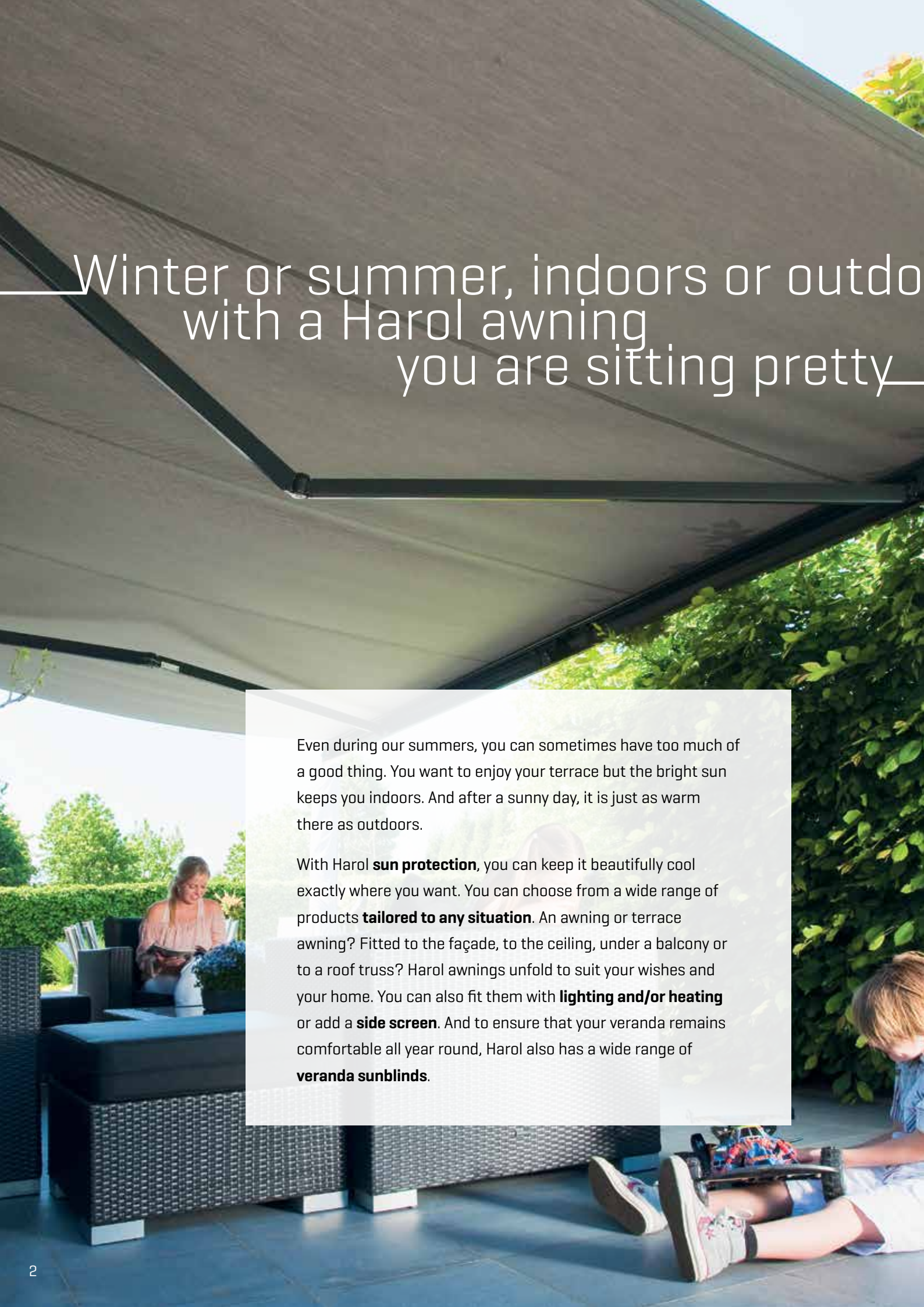

Winter or summer, indoors or outdoors with a Harol awning you are sitting pretty

Even during our summers, you can sometimes have too much of a good thing. You want to enjoy your terrace but the bright sun keeps you indoors. And after a sunny day, it is just as warm there as outdoors.

With Harol **sun protection**, you can keep it beautifully cool exactly where you want. You can choose from a wide range of products **tailored to any situation**. An awning or terrace awning? Fitted to the façade, to the ceiling, under a balcony or to a roof truss? Harol awnings unfold to suit your wishes and your home. You can also fit them with **lighting and/or heating** or add a **side screen**. And to ensure that your veranda remains comfortable all year round, Harol also has a wide range of **veranda sunblinds**.



Discover the new
LED lighting
in the LX530 and the BX270!
Read more at page 12 and 20.

ors:

What type of sun protection do you prefer?

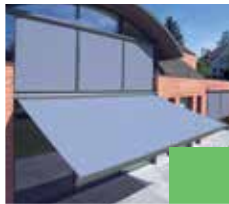

p. 4

>> Harol awnings



p. 26

>> Harol side wind
and sun awning



p. 36

>> Harol Storelight
and/or heating



p. 40

>> Harol veranda
sunblinds

Whichever solution you choose, Harol's **benefits** and **quality warranties** come free:

- > always a **pleasant climate**
- > **protects** furniture, wallpaper, flooring and curtains **against discolouration**
- > the fabrics are made in accordance with the **VEROZO and ROMAZO standards** [= the association of roller blind and sun protection manufacturers]
- > custom-made to **your terrace**
- > designed from highly **durable materials**
- > **technical feats**
- > infinite **colour palette** (all RAL colours at standard price)
- > **functional design**
- > **modern ease of use:**
from manual operation to home automation
- > **5-year warranty**

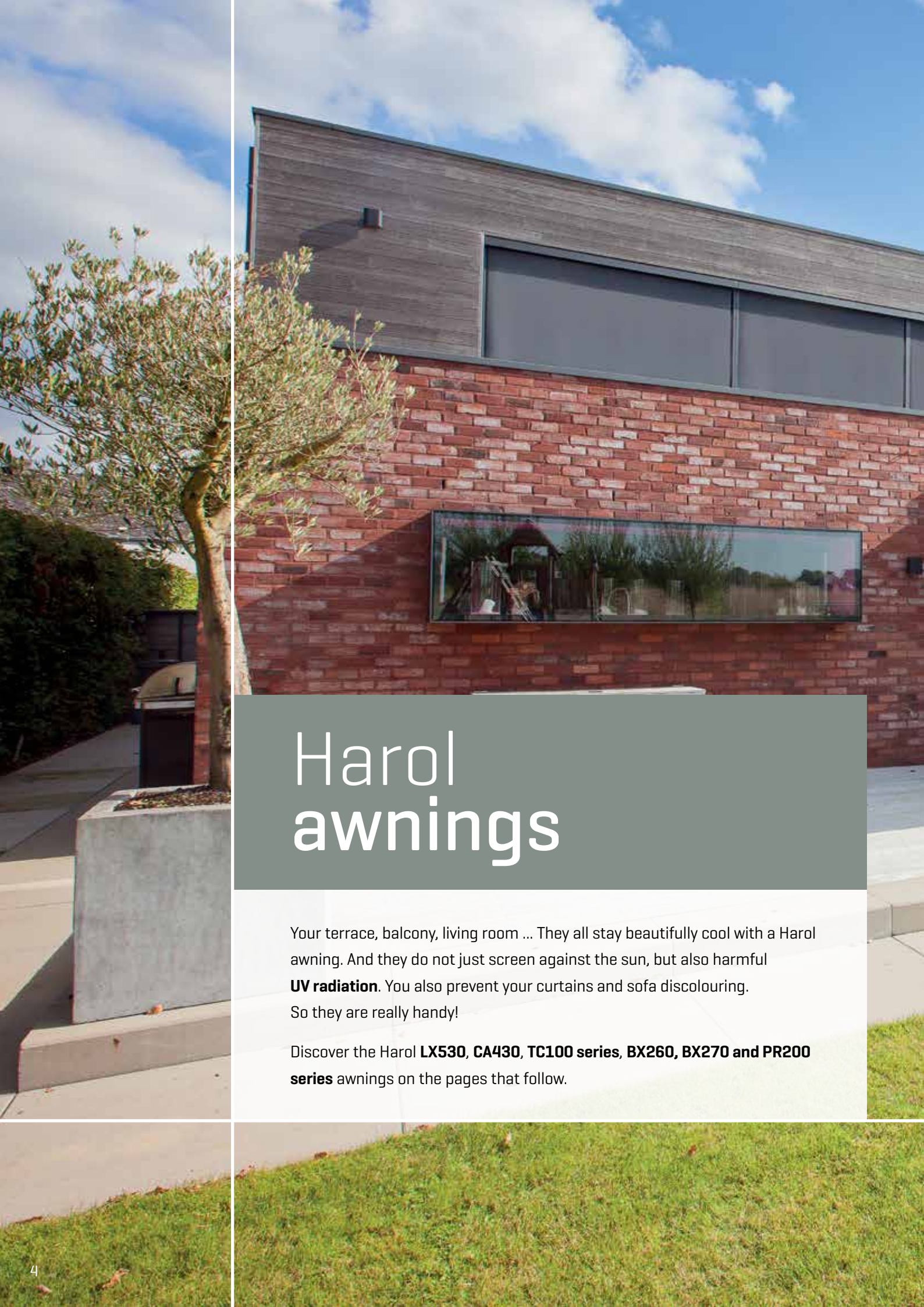

Harol awnings

Your terrace, balcony, living room ... They all stay beautifully cool with a Harol awning. And they do not just screen against the sun, but also harmful **UV radiation**. You also prevent your curtains and sofa discolouring. So they are really handy!

Discover the Harol **LX530, CA430, TC100 series, BX260, BX270 and PR200 series** awnings on the pages that follow.

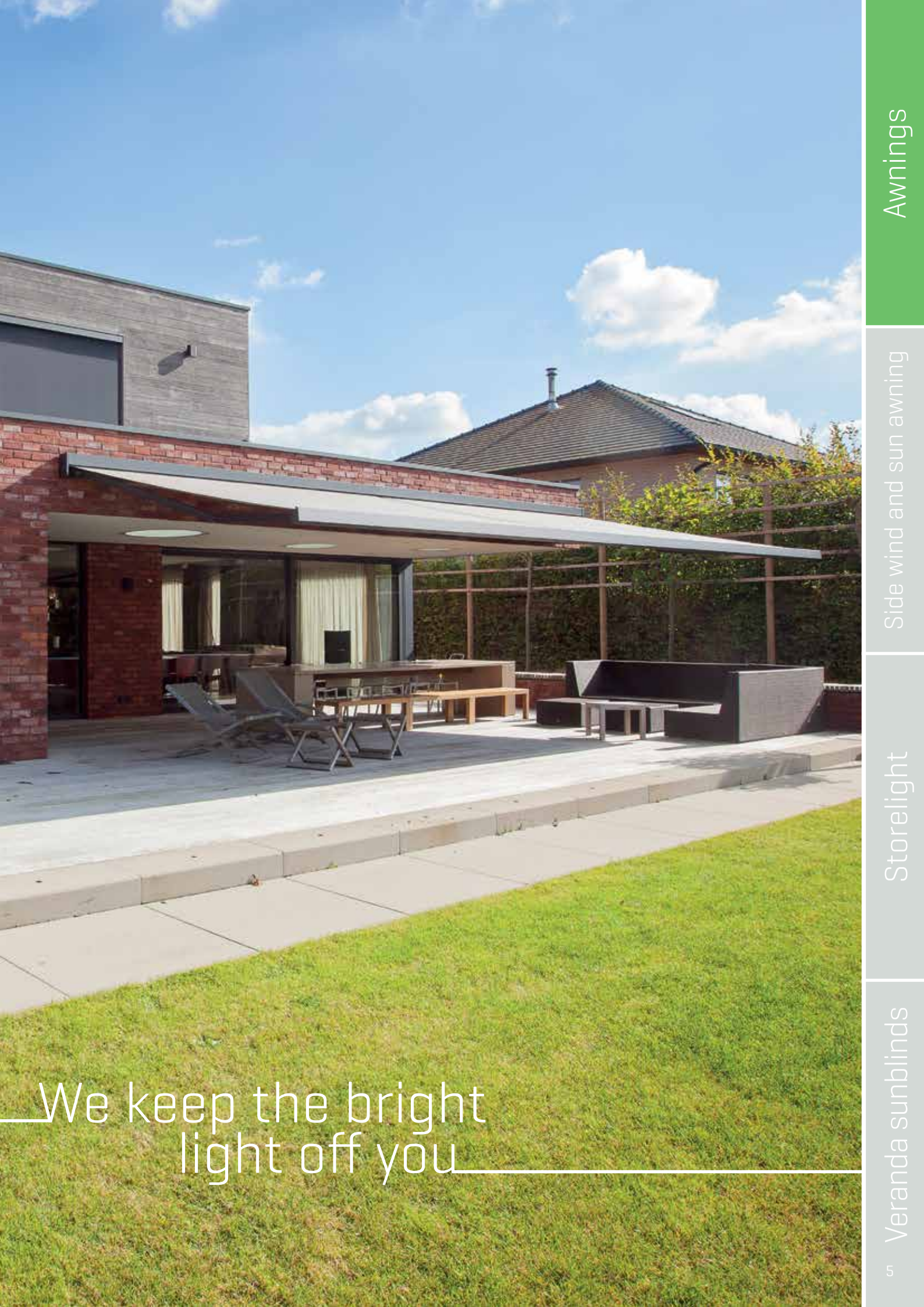

We keep the bright
light off you

Veranda sunblinds

Storelight

Side wind and sun awning

Awnings



Flexible fitting options and types

Wherever you want to **fit** your awning, Harol always has a solution. Awnings can be fitted to the façade, to the ceiling, under a balcony, to a roof truss etc. There are also **various types** of awning, each with their own design and specific technical options. There are awnings with a fully closed box, a semi-open box or an open box. The choice depends on your taste and the extent to which the fabric must withstand the effects of the weather.

TC130



TC130

Frames in the **colour of your choice**

Harol awnings can be completely adapted to your personal taste. Not only do you have a wide range of fabrics, the frames are also available in a broad spectrum of **RAL and structured paints**.

■ **Wide range of colours**

You can choose any colour you want for the frame of your awning. The Storelight lighting and heating system can also be finished in the same colours so that it always forms a beautiful whole with your awning.

■ **Structured paints**

Harol also offers you a range of **prestigious structured paints** with a grainy structure. These paints are particularly wear-resistant and scratch-proof, as well as very easy to maintain. Structured paint gives your awning a stylish, contemporary look.





Superb UV resistance

Of course your personal **taste** is critical in the choice of fabric. But did you also know that **comfort** is indissoluble with the colour of the fabric? Awnings in a pale colour allow more light through than awnings with darker colours. They are always extremely efficient: they filter **over 90% of UV radiation** – equivalent to a factor 50 sun cream.

■ Resistant to weather and wind

Your fabric looks great for a long time because Harol only uses specially-treated acrylic fabrics that are **rot and mildew-resistant and dirt-repellent**. Some types of awning can also be fitted with a polyester fabric.

■ 1001 options

Fabric type:	acrylic
Composition:	spun dyed acrylic fibre, coloured in the mass
Colours:	fancy and uni-colours as per the collection book
Thickness:	± 0.5 mm
Properties:	treated against rot and mould, dirt-repellent
Optional:	self-cleaning MAX fire class M1 Alto FR



Extremely simple operation

You can roll up your awning in a trice with a **laying hook**. Or even easier: at the press of a button with **various types of remote control**. All these need is the wiring to the motor. Would you like an **automatic wind & sun screen**? This furls or unfurls your awning depending on the light intensity and wind speed. How wonderful to come home to a cool veranda after a summer's day at work. A **rain sensor** ensures that your fabric is immediately furlled when it begins to spit with rain.





Quality and warranties

- **All Harol products are CE certified**

This means they comply fully with the **European Directives** on health, safety and the environment.

- **Harol offers a 5-year warranty on your awning**

We can do this quite happily because our awnings are subjected to the most stringent tests. For example, the systems are subjected to **20,000 movements** and are tested robustly for their resistance to **wind load**.

- **Professional Harol partners**

When you contact our partners, you can be sure of receiving expert **advice**, professional **fitting** and prompt **service**.



BX260

- **Harol always offers custom work**

Your awning is always supplied to the exact dimensions of your terrace.

- **Superb quality**

Harol only uses **the best quality awning fabrics**. They are highly durable and exceptionally strong. The fabrics are treated with a special waterproof coating which repels dirt and grease, stops mould and will not rot. Moreover they are **extensively tested** for their **weather resistance** and **colour fastness**. The boxes on cassette awnings also close completely so the fabrics are perfectly protected even in winter.

As with all Harol awnings, rust does not stand a chance.

The box and extension pole are made of extruded, powder-coated **aluminium**.

Only high-quality **stainless steel** is used for the fastening materials.

Keep up with the latest trends.

Visit www.harol.eu and click on 'News'.

The luxury awning for large terraces

WITH PRE-ASSEMBLED
LED STRIP

LX530

The LX530 awning is one of the most deluxe models in the Harol range. With its **drop or depth of at least 4 metres**, it is ideal for a large terrace area. It is also always equipped with **electric operation**: just press a button to open or close the awning.

Have you sometimes had enough of the low sun? Then choose the optional electric vario valance to screen against low sun rays.

And finally HAROL presents the first **pre-assembled LED strip** on the popular LX530 sun protection. Lighting on the sun protection is not a new phenomenon, but HAROL is the first not to mount the LED strip onto the folding arms, but to subtly integrate it into the bottom of the cassette. It enables the strip to be used both in a closed and an open position, with **dimnable** atmospheric and functional lighting.

Design and models

The LX530 has a **fully closed box**, which means that the awning can even be fitted in places that are exposed to the rain or wind and keeps your fabric looking great for much longer.

2 **folding arms** are provided up to a width of 6 m, from 6 to 7 m the awning is equipped with 3 arms and 4 arms are fitted for coupled awnings (up to a width of 12 m). These arms each have 2 built-in **pull springs** which will extend the service life of your awning by many summers.

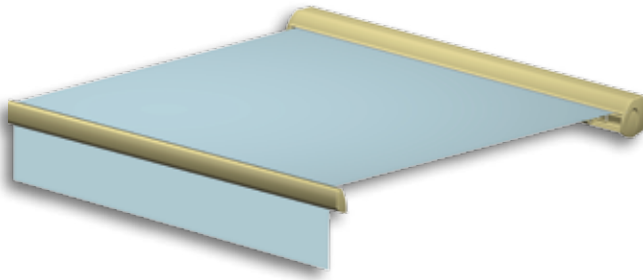

Fitting to the trusses roof trusses*

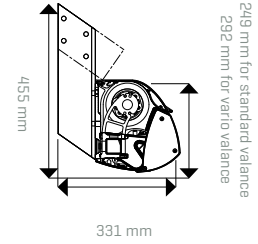

Fitting to the wall wall brackets

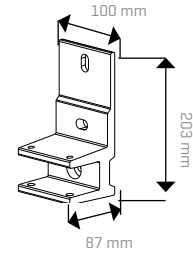

Fitting to the ceiling ceiling bows*

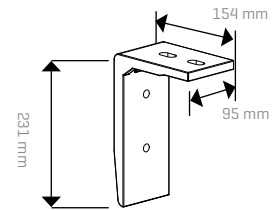

* always used together with wall brackets

Fitting options

The awning is fitted with robust wall brackets which are discreetly **concealed at the back of the box**. The number of wall brackets depends on the width of the awning.

Angle and run-out height

Like many Harol products, the awnings are custom-made.

$10^\circ \leq \text{angle} \leq 45^\circ$ · A=drop · B=height difference · fitting at min. 2.5 m height

A (mm)	B (mm)	A (mm)	B (mm)
1500	260	1500	1061
2000	347	2000	1414
2500	434	2500	1768
3000	521	3000	2121
3500	608	3500	2475
4000	695	4000	2828

LX530

Max. width	Max. drop	Min. drop
7 m (12 m in 2 parts)	4 m	1.5 m

A blue retractable awning with modern trim is shown over a patio area. The awning is extended, covering a table and chairs. The background shows a well-maintained garden with a lawn, trees, and a house. The sky is blue with white clouds.

The stylish awning
with modern trim

CA430

The CA430 keeps your terrace cool whilst keeping the sun away from your windows. In poor weather, the fabric and awning are safely stored in an **aluminium cassette**. A sensible **water drainage system** prevents water seeping into the box when the awning is closed to keep your fabric looking great for much longer. The strong arms with built-in pull springs are also ready for heavy use. The **trim**, which matches the fabric colour, provides a fresh finish.

Design and models

The CA430 has a **fully closed box**, which means that the awning is ideal even for places that are exposed to the rain or wind. A sensible **water drainage system** prevents water seeping into the box when the awning is closed to keep your fabric looking great for much longer.



Fitting to the trusses
roof trusses*

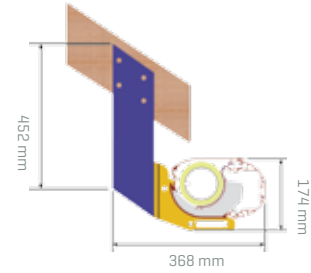

Fitting to the wall
wall brackets

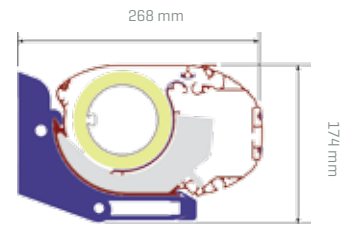

Fitting to the ceiling
ceiling bows*

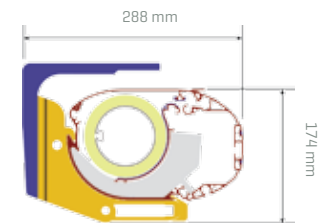

* always used together with wall brackets

Fitting options

The awning is fitted with robust, adjustable wall brackets which are discreetly **concealed behind the box**. The number of wall brackets depends on the width of the awning.

Dimensions

Like many Harol products, the awnings are custom-made.

$10^\circ \leq \text{angle} \leq 45^\circ \cdot A = \text{drop} \cdot B = \text{height difference} \cdot \text{fitting at min. 2.5 m height}$

A (mm)	B (mm)
1500	260
2000	347
2500	434
3000	521
3500	608

A (mm)	B (mm)
1500	1061
2000	1414
2500	1768
3000	2121
3500	2475

CA430

Max. width	Max. drop	Min. drop
7 m	3.5 m	1.5 m



Compact, flexible,
can be fitted anywhere

TC100 series

The Harol **TC130** awning features a compact design, rapid adjustment and universal uses. You can easily adjust the angle to determine how much shade you want.

The awning is made from stainless steel and aluminium. In addition to the TC130 with a closed box, you can also choose the **TC120** with a semi-open box.

Design and models

The box finish varies depending on the type you choose. The **TC120** has a semi-open box which screens the fabric at the top. The fully closed box of the **TC130** offers optimum fabric protection against rain or wind in an aesthetically pleasing unit.

The **aluminium covers** on the extension pole also guarantee a perfect finish. The TC120 has a small, low extension pole with a valance. The TC130 is fitted with a high extension pole with no valance as standard.

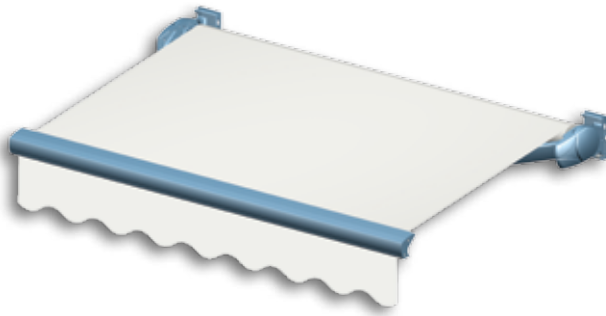

Fitting to the wall
from 0° to 76°

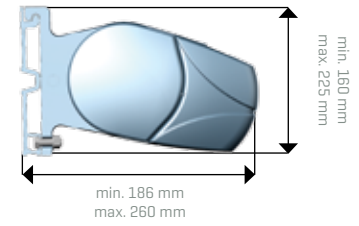

Fitting to the ceiling
from 14° to 90°

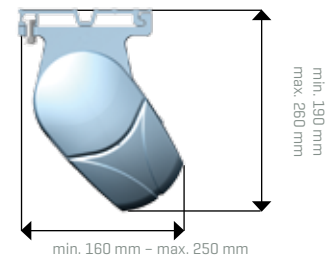

Fitting options

The typical feature of the TC100 series awnings is their **easy angle adjustment** which can range from 0° to 90°. There is just one type of bracket for both fitting methods.

Dimensions

Like many Harol products, the awnings are custom-made.

0° ≤ angle ≤ 90° · A=drop · fitting at min. 2.5 m height

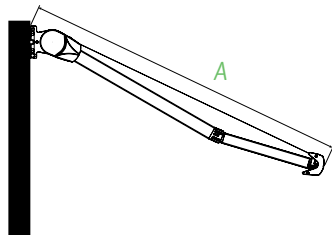

A (mm)
1500
2000
2500
3000

TC100





Perfect design
on any façade

BX260

With its **small dimensions** (minimum depth of 15 cm), the BX260 awning can be perfectly integrated into any façade. The special construction with wide wall brackets allows the awning to be fitted onto practically any surface. The **closed cassette system** ensures that the fabric is completely protected against dirt and inclement weather. The extension pole also has an **integrated water drain**. Harol provides 2 folding arms up to a width of 6 m, from 6 to 7 m the awning is equipped with 3 arms and 4 arms are fitted for coupled awnings (up to a width of 12 m). For anyone who wants to create a **cool format!**

Design and models

The BX260 has a **fully closed box** with the benefit that the awning is also suitable for places that are exposed to the rain or wind and your fabric stays looking great for much longer. With its low depth, the box is **exceptionally compact**. Another typical feature of the BX260 is the **load-bearing supporting plate** into which the brackets, folding arms and roller shaft are hooked. 2 folding arms are provided up to a width of 6 m, from 6 to 7 m the awning is equipped with 3 arms and 4 arms are fitted for coupled awnings (up to a width of 12 m). These arms each have 2 built-in pull springs which will extend the **service life** of your awning by many summers.

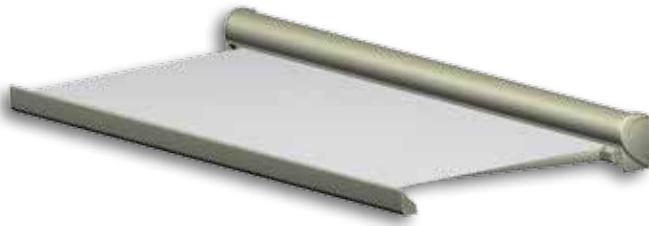

Fitting to the wall
wall brackets

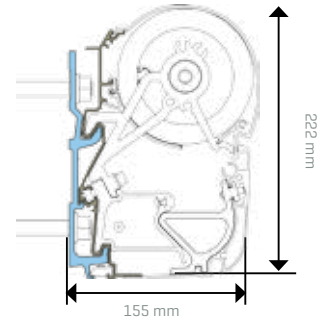
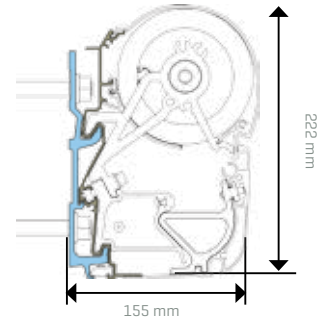

Fitting options

The awning is fitted by **hooking it into broad wall brackets** that are fitted to the mounting surface first. The number of brackets depends on the width of the awning.

Dimensions

Like many Harol products, the awnings are custom-made.

$10^\circ \leq \text{angle} \leq 35^\circ$ · A=drop · B=height difference · fitting at min. 2.5 m height

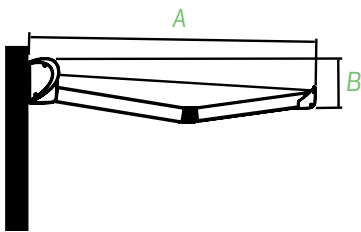

A (mm)	B (mm)
1500	260
2000	347
2500	434
3000	521
3500	608

A (mm)	B (mm)
1500	860
2000	1147
2500	1434
3000	1721
3500	2008

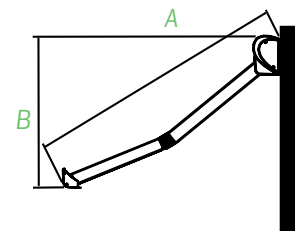

BX260

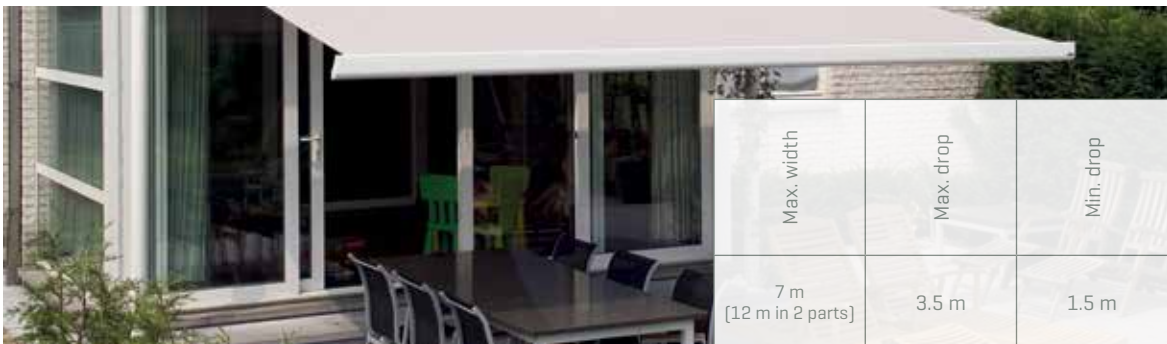

Max. width	Max. drop	Min. drop
7 m [12 m in 2 parts]	3.5 m	1.5 m



A sleek and stylish design

BX270

WITH LED LIGHTING

The BX270 awning is a further development of the BX260 model, and a direct hit within this range as it addresses a number of issues. With its **sleek design** and the fact that it is available in a wide range of RAL and textured paints, with varying degrees of gloss, the BX270 guarantees a **harmonious embellishment for your façade**.

Furthermore, the **closed cassette system** ensures that the fabric is fully protected, even in places that are not sheltered from rain or wind. Sun protection in the daytime, atmospheric after sunset ... The sleek BX270 folding arm awning is now also available with **LED lighting**. The dimmable, energy-efficient lighting instantly creates a cosy atmosphere.

Design and models

The BX270 is identical to the BX260 with its **fully enclosed box**, yet its appearance has been given a complete makeover. This consists mainly of a **brand new side console** in **aluminium casting**, a stylish **stainless steel brushed logo** and an extremely **sleek** extension pole design with integrated water drainage. The limited depth **makes the box extremely compact**. Also typical for the BX270 is the **load-bearing torque** bar onto which the supports, folding arms and fabric roll are hooked. Up to a width of 6 m there are 2 folding arms, and from 6 to 7 m the screen is fitted with 3 arms; for coupled awnings [up to a width of 12 m] 4 arms are fitted. These arms always have 2 integrated pull springs which will extend the **service life** of your awning with many more summers.



With LED Lighting



Fitting to the wall
wall brackets

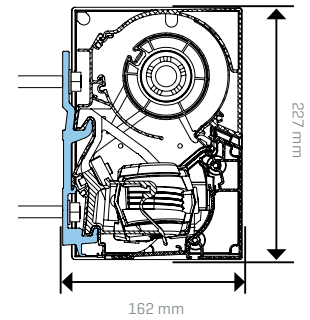

Fitting options

The awning is fitted by simply **hooking it into broad wall** brackets that are first fitted to the mounting surface. The number of brackets depends on the width of the awning.

Measurements and angle

Like many Harol products, the awnings are custom-made

$10^\circ \leq \text{angle} \leq 35^\circ \cdot A = \text{drop} \cdot B = \text{height difference} \cdot \text{fitting at min. 2.5 m height}$

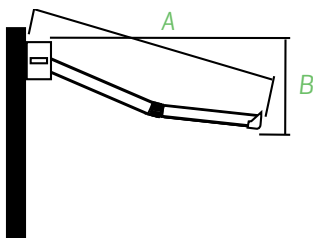

A (mm)	B (mm)
1500	260
2000	347
2500	434
3000	521
3500	608

A (mm)	B (mm)
1500	860
2000	1147
2500	1434
3000	1721
3500	2008

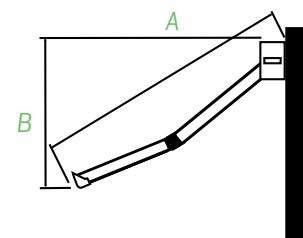

BX270





Aluminium covers
for a perfect finish

PR200 series

Harol PR awnings are easily identified by their **aluminium covers**. Just like the other PR awnings, the PR230 offers perfect protection against too much sun, with a width of 7 metres [in 1 part] to 12 metres [in 2 parts]. The awning is fitted as standard with a low, round extension pole with a **valance**.

An extremely useful option is the **vario valance** (up to 1.5 m) which has been specially developed to counter low sun.

Design and models

The box finish varies depending on the type you choose. The **PR210** has an open box: ideal for fitting under a balcony or overhang when the fabric does not need extra protection. The **PR220** has a semi-open box which screens the fabric at the top.

The fully closed box of the **PR230** offers optimum protection of the fabric against rain and wind. It also creates an aesthetically pleasing unit. The **aluminium covers** on the extension pole also help make a perfect finish. The standard model has a round extension pole with a **valance**. A high extension pole is possible as an option.

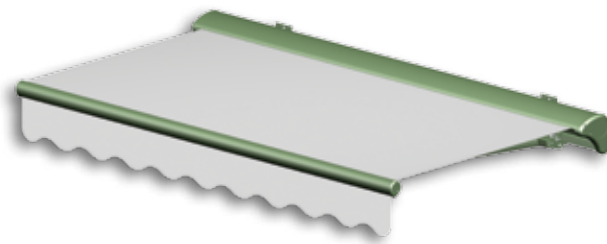

Fitting options

The awning is fitted with robust, adjustable wall brackets which are discreetly **concealed at the back of the box**. The number of wall brackets depends on the width of the awning.

Dimensions

Like many Harol products, the awnings are custom-made.

Fitting to the trusses
roof trusses*

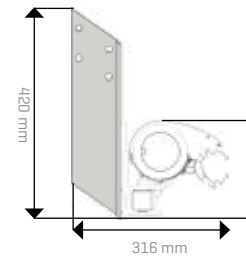

Fitting to the wall
wall brackets

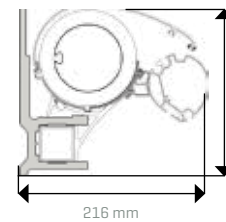

Fitting to the ceiling
ceiling consoles*

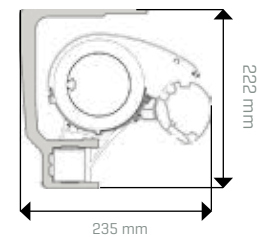

* always used together with wall brackets

$10^\circ \leq \text{angle} \leq 45^\circ$ · A=drop · B=height difference · fitting at min. 2.5 m height

	<table border="1"> <thead> <tr> <th>A (mm)</th> <th>B (mm)</th> </tr> </thead> <tbody> <tr> <td>1500</td> <td>260</td> </tr> <tr> <td>2000</td> <td>347</td> </tr> <tr> <td>2500</td> <td>434</td> </tr> <tr> <td>3000</td> <td>521</td> </tr> <tr> <td>3500</td> <td>608</td> </tr> </tbody> </table>	A (mm)	B (mm)	1500	260	2000	347	2500	434	3000	521	3500	608	<table border="1"> <thead> <tr> <th>A (mm)</th> <th>B (mm)</th> </tr> </thead> <tbody> <tr> <td>1500</td> <td>1061</td> </tr> <tr> <td>2000</td> <td>1414</td> </tr> <tr> <td>2500</td> <td>1768</td> </tr> <tr> <td>3000</td> <td>2121</td> </tr> <tr> <td>3500</td> <td>2475</td> </tr> </tbody> </table>	A (mm)	B (mm)	1500	1061	2000	1414	2500	1768	3000	2121	3500	2475	
	A (mm)	B (mm)																									
1500	260																										
2000	347																										
2500	434																										
3000	521																										
3500	608																										
A (mm)	B (mm)																										
1500	1061																										
2000	1414																										
2500	1768																										
3000	2121																										
3500	2475																										

	Max. width	Max. drop	Min. drop
	7 m [12 m in 2 parts]	3.5 m	1.5 m

PR200



SC700
BX270



BX270

Be inspired!

Looking for the awning that is best suited to you and your garden or terrace?
Or are you looking for ideas to create your ideal outdoor space?

Why not take a look at www.harol.eu and click on 'Inspiration'.
You'll find a wide range of projects, suitably adapted to any situation



BX260

Awnings

Side wind and sun awning



LX530

Storelight

Veranda sunblinds

Awnings overview

	TC series	PR series	BX260	BX270	CA430	LX530
						
Box type [important for protecting the fabric]	Open: TC110, semi-open: TC120 or closed box: TC130	Open: PR210, semi-open: PR220 or closed box: PR230	Closed box with weathering and water drainage system	Closed box with weathering and water drainage system	Closed box with weathering and water drainage system	Closed box with weathering
Valance [250 mm suspended fabric on the extension pole]	Standard for TC110 and TC120. In option for TC130. Choose 4 types: 	Standard: Choose 4 types: 	In option. Choose 4 types: 	In option. Choose 4 types: 	In option. Choose 4 types: 	In option. Choose 4 types: 
Vario valance [extra suspended fabric against low sun, max. 2 m]	No	Manual option	No	No	No	Electric option
NEW Integrated lighting [LED]	No	No	No	In option	No	In option
NEW Integrated lighting [LED] with dimmable atmospheric	No	No	No	In option	No	In option
Maximum width	5.5 m	7 m [12 m in 2 parts]	7 m [12 m in 2 parts]	7 m [12 m in 2 parts]	7 m	7 m [12 m in 2 parts]
Maximum drop	3 m	3.5 m	3.5 m	3.5 m	3.5 m	4 m
Operation	Manual or electric	Manual or electric	Manual or electric	Manual or electric	Manual or electric	Electric
Weight	TC110: ± 8 kg/m TC120: ± 9 kg/m TC130: ± 11 kg/m	± 14 kg/m	± 14 kg/m	± 18 kg/m	± 18 kg/m	± 19 kg/m



CA430

See examples of our awnings fitted.
Go to www.harol.eu to see if yours qualifies.



What sets Harol awnings apart?

LX530

- width up to 7 m in 1 part, up to 12 m in 2 parts
- up to 4 m drop
- up to 4 folding arms with dual built-in pull springs
- fully closed box with weathering
- ordinary valance or optional vario valance
- integrated LED lighting in option
- integrated LED lighting with **dimnable atmospheric** in option

CA430

- fully closed box with weathering
- extension pole with integrated water drainage
- arms with dual built-in pull springs
- trim strips matching the fabric colour
- optional valance

TC100 series

- different box types depending on where the awning is fitted
- high extension pole on TC130 that completely closes the box
- compact design awning with relatively low weight
- easy angle adjustment from 0° to 90°, depending on fitting
- valance as standard on TC120 and TC110

LX530



BX260

- width up to 7 m in 1 part, up to 12 m in 2 parts
- compact box shape
- fully closed box with weathering
- extension pole with integrated water drainage
- optional valance

BX270

- Width up to 7 m for 1 unit, up to 12 m for 2 units
- Compact box shape
- Sleek design
- Side console made from aluminium casting
- Optional valance
- Integral brushed stainless steel logo
- integrated LED lighting in option
- integrated LED lighting with **dimnable atmospheric** in option

NEW

PR200 series

- width up to 7 m in 1 part, up to 12 m in 2 parts
- different box types depending on where the awning is fitted
- valance as standard
- optional vario valance to counter low sun
- Optional: high extension pole with no valance



Would you like more information about Harol side folding arm awnings?

- Then have a look at www.harol.eu
- Or contact your **Harol partner** without any obligation.
You will find the necessary details on the back of this brochure.



Harol SL400

The Harol **SL400 side wind and sun awning** unfurls however you want. Out of the wind but in the sun? Or do you prefer to be in the shade? You can choose and just enjoy the results because this awning also screens your terrace, balcony or garden from being overlooked.

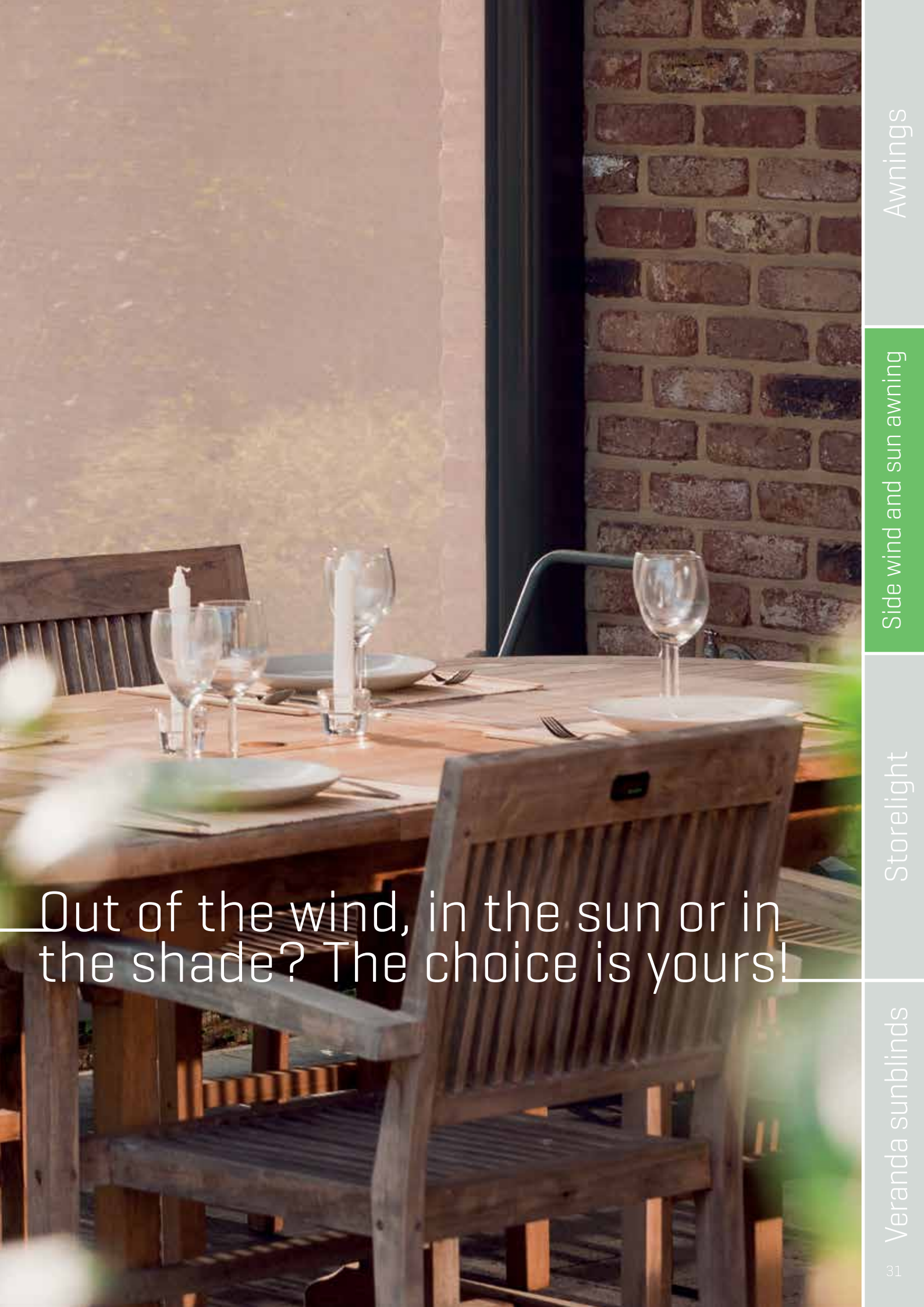

Out of the wind, in the sun or in the shade? The choice is yours!

Awnings

Side wind and sun awning

Storelight

Veranda sunblinds



SL400

Innumerable options

This awning allows you to turn your terrace into a budget-friendly and original 'outdoor room' in the blink of an eye. The various fitting options mean you can be protected against wind or excessively bright sun anywhere in your **garden** or on your **terrace** or **balcony**. You can also choose between a **straight or oblique wind and sun awning**. The latter is very useful if, for example, you want to use the SL400 as the ideal side closure in **combination with a folding arm awning**.

Simple operation

You can operate this wind and sun awning in a trice. The **pull rod with handle** is pulled out and hooked into a fixed **bracket profile**.

A **wheel** underneath the pull rod guarantees even smoother operation. The awning fabric is tensioned by an **integrated coiled spring**. A **safety system** (child lock) prevents the awning rolling up unexpectedly.



SL400

Awnings

Side wind and sun awning

Entirely custom-made

Harol offers you the choice of any **colour**. Choose from the full range of **RAL colours** or opt for one of the **prestigious structured paints**.

You can also choose from the extensive collection of **acrylic fabrics** which are available in a broad spectrum of colours and designs.

Durable materials

Systems intended for outdoor use must be shockproof. The SL400 is made from high-quality **corrosion-resistant materials**. They have protective **coatings** and, like all Harol sun protection systems, they are **CE certified**. Durability guaranteed – which is why you will enjoy at least a **5-year warranty**.



Storelight

Veranda sunblinds





SL400

Straight

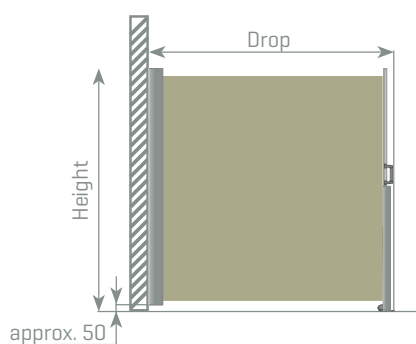

Oblique

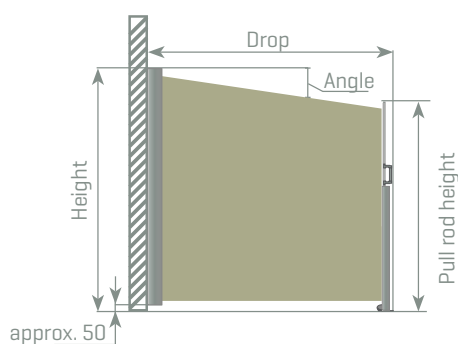

Operation	Manually using a built-in coiled spring	
Colours	· All RAL colours and structured paints are possible	
Fabrics	· Acrylic fabrics · Polyester fabrics	
Dimensions	STRAIGHT	OBLIQUE
Min. height (incl. 50 mm from the ground)	1350 mm	1450 mm
Max. height (incl. 50 mm from the ground)	2150 mm	2550 mm
Min. drop	1000 mm	1000 mm
Max. drop	4000 mm	4000 mm
Min. height pull rod		600 mm
Max. height pull rod		2400 mm
Angle		5° - 15°

Would you like more information about Harol side wind and sun awnings?

- Then have a look at www.harol.eu
- Or contact your Harol partner without any obligation.
You will find the necessary details on the back of this brochure.

Harol Storelight

The **Storelight II** is for anyone who wants to create a sociable atmosphere on their terrace in the evening. Do you want to illuminate your terrace after nightfall? Or would you like a **heating system** so that you can still enjoy your terrace when the temperature is a bit fresher? Or if you cannot decide: we can also integrate both functions into a single system.



Lighting and heating à la carte



Awnings

Side wind and sun awning

Storelight

Veranda sunblinds



TR850



There are **3 variants**:

■ **Lighting system**

This handy system is perfectly matched to your sun protection and consists of **4 or 5 halogen spotlights depending on the length**, which can be rotated in any direction. The built-in spots can be rotated 355° and tilted 60°. The system is available in **lengths of 2.5 or 3.5 metres**. The aesthetically pleasing box is made from lacquered aluminium and is available in all RAL colours. Useful: the spotlights do not attract any annoying insects in the evening!

■ **Heating system**

There is a system with built-in heating, especially for colder periods or for garden parties into the small hours. This version has an **infrared radiator (2000 W)** with a range of 16 m². If it becomes too cool, just flip the switch and it will very soon be pleasantly warm.

■ **Lighting and heating system**

The third version of the Storelight II combines **light and heat**. This version has **two infrared radiators (1400 W)** and **3 spotlights (20 W)**. Ideal for anyone who wants to make the most of the late summer!

If you choose the Storelight II with just lighting or heating, the system is fitted to the wall using 2 to 3 **chrome brackets**. If you choose the Storelight II with both lighting and heating, the fittings have **T-shaped anodised brackets**.

Optionally, the lighting system can be installed by fitting the **brackets around the square torque bar (40 x 40 mm)** of the folding arm awning. With cassette folding arm awnings, the fitting brackets are secured **directly to the fitting surface immediately under the folding arm awning**.



Would you like more information about Harol Storelight?

- Then go to www.harol.eu
- Or contact your **Harol partner** without any obligation.
You will find the necessary details on the back of this brochure.



Harol veranda sunblinds

A Harol veranda sunblind is the ideal solution to keep the temperature on your veranda under control. Not just the **heat**, the ingress of light is also metered so you can prevent your furniture, curtains and wallpaper discolouring.

The Harol veranda sunblind is **custom-made sun protection** which is fitted over your veranda. It therefore counters the heat of the sun before it can spread into your home via the glass. The space between the glass and the sunblind allows **good air circulation**. This means any heat that builds up is permanently dissipated between the glass surface and the fabric. A Harol veranda sunblind is therefore **the ideal temperature control!**

The wide choice of **frame and fabric colours** allows you to match your veranda sunblind perfectly to the colour of your veranda profiles and your façade, making your veranda even more of an **extension of your home** where it is always pleasant to spend time.

Enjoy your veranda
all year round

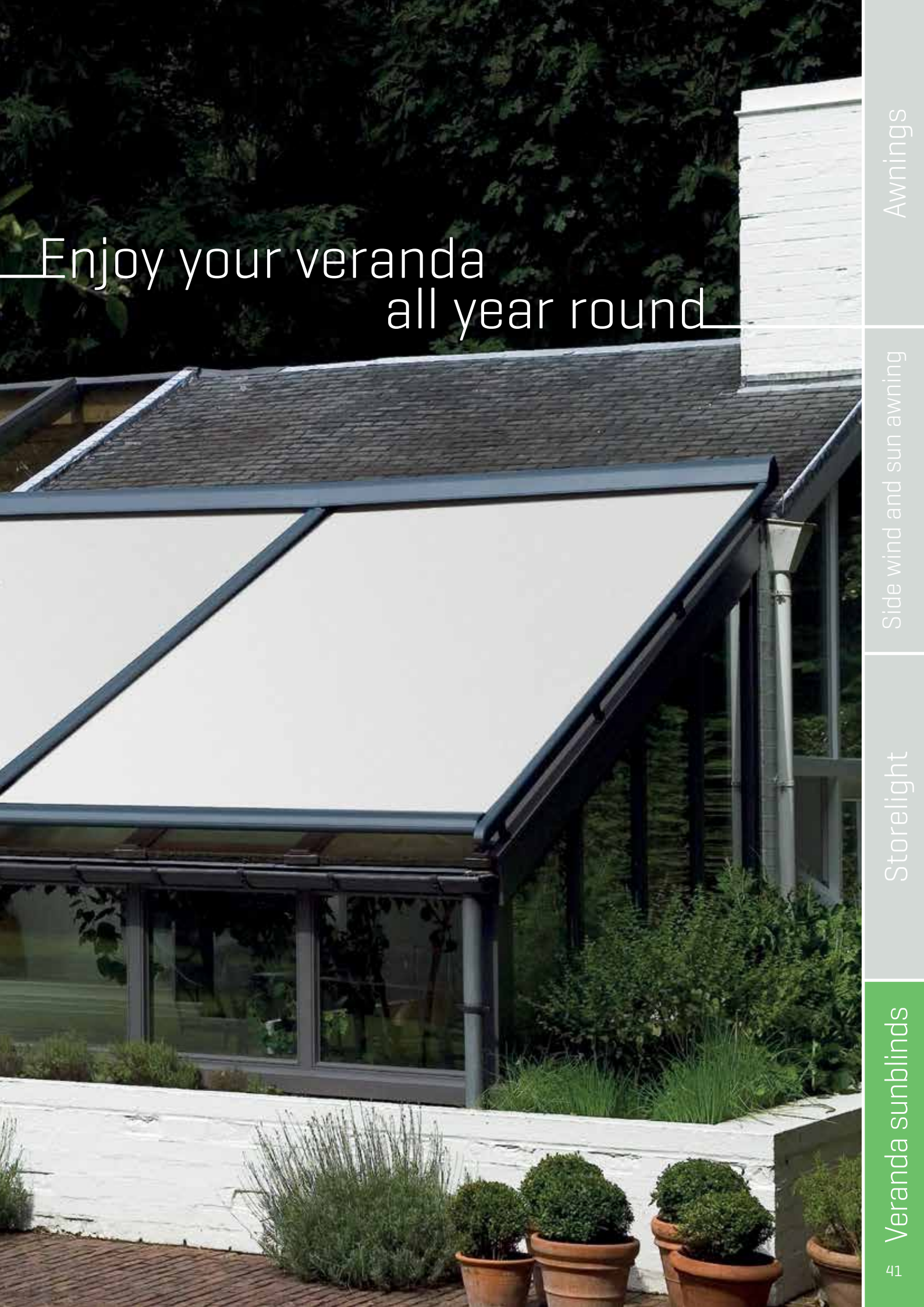

Awnings

Side wind and sun awning

Storelight

Veranda sunblinds



Pioneering in **operation** and **home automation**

The Harol veranda sunblind combines a **high quality finish** with a **contemporary design**. It is suitable for fitting to any common veranda construction.

The whole unit is made of **corrosion-resistant materials** and the sunblind fabric is completely concealed in the box when it is furled. **Weather** from outside therefore has no chance. The box is attached to guide rails which are secured to the veranda profiles by means of **fastening brackets**. These brackets are available in aluminium or plastic as you prefer. Raised brackets are available for roof windows in the veranda roof and increase the distance between the blind and the glass roof.

The **fabric** is kept at a safe distance from the veranda roof by the position of the guide rails and a cable spring system that keeps the fabric under constant tension. There is a space between the lateral guides and the fabric to ensure **good ventilation and heat dissipation**.



WIND-SUN AUTOMATION



Fabrics in **many variations**

■ **Acrylic fabrics**

water-repellent and dirt-resistant and treated against mould and rotting. These fabrics are available in plain colours or with colourful patterns. You can also choose from fire-repellent fabrics and/or water-resistant fabrics as options.

Colourful fittings

You can choose from the full **RAL colour palette** and **all structured paints**.





Harol offers **2 types** of veranda sunblind:

VZ510

- Box consists of **roll-formed aluminium profiles**. [1]
- **Plastic brackets** to fasten the veranda sunblind to the veranda roof. Standard on the VZ510. [2]
- The **rounded shape of the guide rails**, for example, shows that great importance has been attached to the design. [3]
- **The fabric and the extension pole** are kept under constant tension by means of a spring, wheels and the hi-tech cord.



1



2



3

Type	Number of elements	Maximum range in metres																Maximum area [m ²]	Max. drop [m]	Number of elements	Number of motors
		1	2	3	4	4,5	5	6	7	8	9	10	11	12	13,5	18					
Type 1	1			1 part														18	6	1	1
Type 2	2				2 parts													36	6	2	1
Type 3	3						3 parts											54	6	3	2
Type 4	4							4 parts										72	6	4	2





VZ520

- Box consists of **extruded** aluminium profiles. [1]
- **Aluminium brackets** to fasten the veranda sunblind to the veranda roof. Standard on the VZ520. [2]
- When the sunblind is furled, the **extension pole** is partly in the box, which not only protects the fabric but also makes the whole unit look good. [3]
- **The carriage with wheels** was specially designed to make the system run gently and hence as good as silently. The wheels can move laterally, which ensures that the extension pole always runs flexibly in the guide rails.

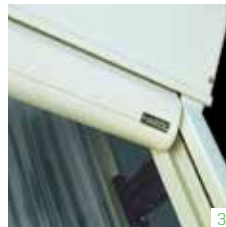

Type	Number of elements	Maximum range in metres																Maximum area [m ²]	Max. drop [m]	Number of elements	Number of motors
		1	2	3	4	5,5	6	7	8	9	10	11	12	13	16,5	22					
Type 1	1			1 part													25	6	1	1	
Type 2	2				2 parts												50	6	2	1	
Type 3	3					3 parts											75	6	3	2	
Type 4	4						4 parts										100	6	4	2	

Would you like more information about Harol veranda sunblinds?

- Then go to www.harol.eu
- Or contact your Harol partner without any obligation. You will find the necessary details on the back of this brochure.



STORELIGHT



TC130



SL400

5

reasons why Harol deserves your trust

1 Installation by **experts**

All Harol awnings are fitted by experts from specialist companies. Each specialist can demonstrate **many years of experience** in this sector. They also regularly attend **Harol training courses** to learn about fitting techniques, maintenance and advice.

2 **100% guaranteed quality**

Not only do all Harol products meet the most **stringent quality standards**, these standards also apply to the way they are manufactured and delivered. Harol offers a **5-year quality guarantee!**

3 **Supplied according to your requirements**

All Harol awnings can be customised to meet **your requirements**. Do you want manual operation on the left or right? A motor with remote control as part of a home automation system? Explain **your requirements** to your Harol partner, and he will make sure they are met. Fancy a separate colour? Again, you have plenty of choice. The arms and frame of our awnings are available in a wide range of standard and RAL colours, and you can choose from a broad spectrum of fabrics, colours and patterns for the fabrics. In short: **you can be sure you will find what you are looking for at Harol.**



TC130

4 Easy to operate

All our awnings are available with **manual or electric operation** and can be fitted with an **automatic wind and sun screen** and/or a **rain sensor** if you wish, to protect your awning against wind and weather. What more could you want?

5 Full service from start to finish

An awning is not the sort of purchase you choose lightly. This is why any Harol partner will help you with **advice and assistance**. Based on your wishes and requirements, he will assist you in finding the perfect solution. As an expert with years of experience he can guarantee a **perfect installation**. You can always contact him for questions about colours, materials and maintenance.

And you can also 100% rely on him for **after-sales service**. When you buy Harol, you buy more than a Harol product.



Would you like more information about Harol awnings?

- Then go to www.harol.eu
- Or contact your Harol partner without any obligation.
You will find the necessary details on the back of this brochure.



HAROL nv

Industriepark 3 3290 Diest
[Belgium]

Tel. +32 13 38 01 11

Fax +32 13 31 48 03

www.harol.eu - info@harol.eu

Your Harol partner: